

# EROSS NEW

Art.-Nr.

395 884  
395 885

1450  
1115  
516  
mm

1/8

v1

48-2024

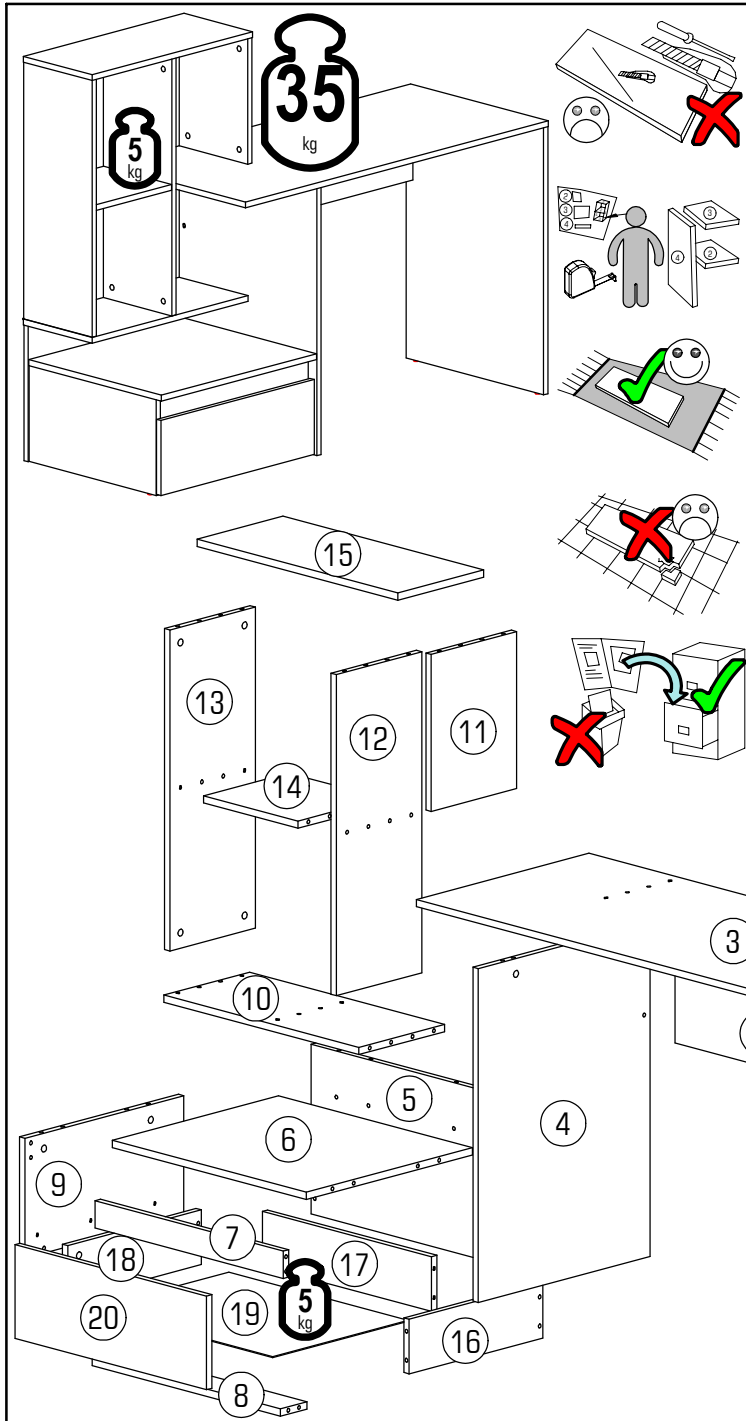
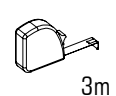
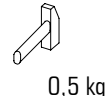
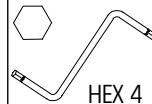
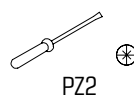
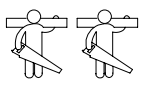



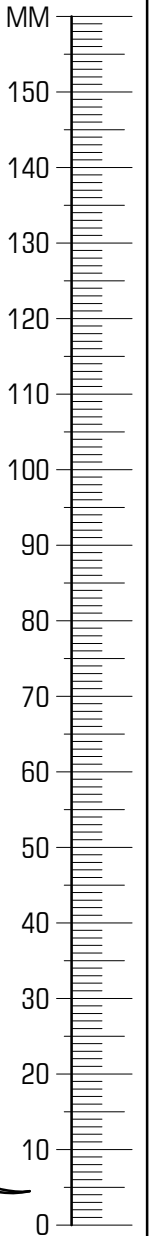

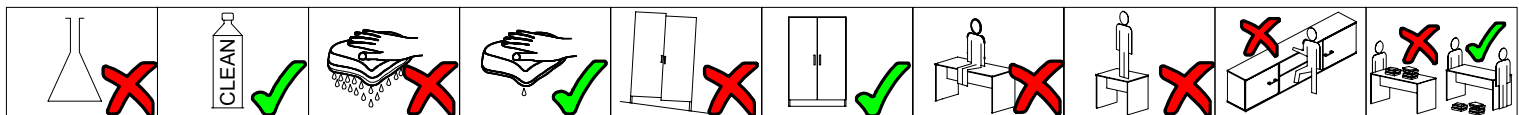

| ID    | ID | Dimensions  | Quantity | Material |
|-------|----|-------------|----------|----------|
| 21281 | 2  | 833*240*16  | 1x       | 1/2      |
| 21282 | 3  | 1134*516*16 | 1x       | 1/2      |
| 21283 | 4  | 734*515*16  | 1x       | 2/2      |
| 21284 | 5  | 583*373*16  | 1x       | 1/2      |
| 21285 | 6  | 581*497*16  | 1x       | 2/2      |
| 21286 | 7  | 564*60*16   | 1x       | 1/2      |
| 21287 | 8  | 564*80*16   | 1x       | 1/2      |
| 21288 | 9  | 264*476*16  | 1x       | 1/2      |
| 21289 | 10 | 584*257*16  | 1x       | 2/2      |
| 21290 | 11 | 345*256*16  | 1x       | 1/2      |
| 21291 | 12 | 706*256*16  | 1x       | 2/2      |
| 21292 | 13 | 706*256*16  | 1x       | 2/2      |
| 21293 | 14 | 283*254*16  | 1x       | 1/2      |
| 21294 | 15 | 601*257*16  | 1x       | 2/2      |
| 20354 | 16 | 400*120*16  | 1x       | 2/2      |
| 21295 | 17 | 507*120*16  | 1x       | 2/2      |
| 20352 | 18 | 400*120*16  | 1x       | 1/2      |
| 21296 | 19 | 406*537*3   | 1x       | 2/2      |
| 21297 | 20 | 574*206*16  | 1x       | 1/2      |
| 21298 | 21 | 734*515*16  | 1x       | 2/2      |

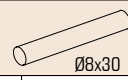

|   |     |   |     |   |     |   |     |   |     |   |    |   |     |   |    |
|---|-----|---|-----|---|-----|---|-----|---|-----|---|----|---|-----|---|----|
|   |     |   |     |   |     |   |     |   |     |   |    |   |     |   |    |
| A | 10x | B | 42x | C | 11x | D | 38x | E | 34x | F | 6x | G | 16x |   |    |
|   |     |   |     |   |     |   |     |   |     |   |    |   |     |   |    |
| H | 8x  | J | 3x  | K | 6x  | L | 2x  | M | 2x  | N | 1x | P | 1x  | R | 2x |

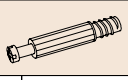

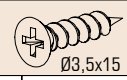
# 2/8 EROSS NEW

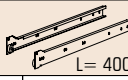
|  |   |   |   |   |   |  |
|--|---|---|---|---|---|--|
|  |  |  |  |  |  |  |
| B 22x  | D 12x   | E 16x   | F 4x  | H 2x  | K 6x  | N 1x   |

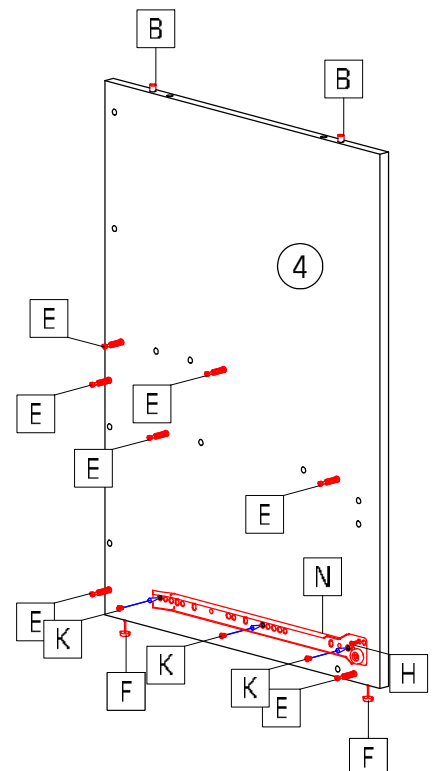
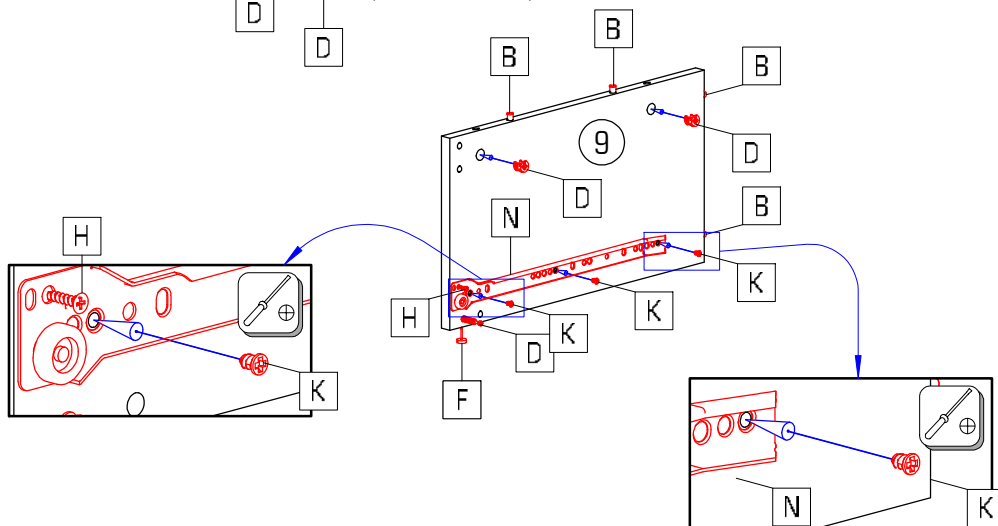
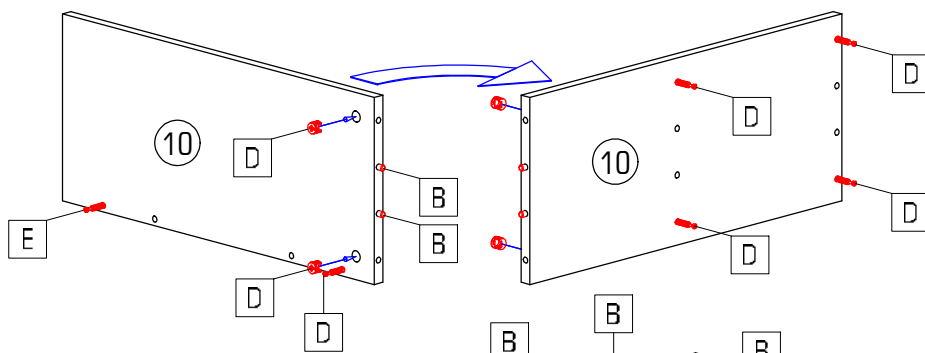
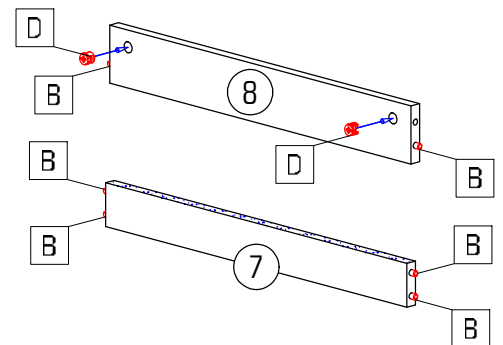
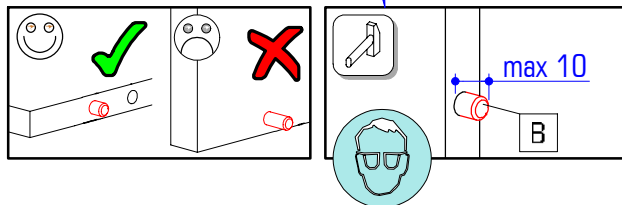
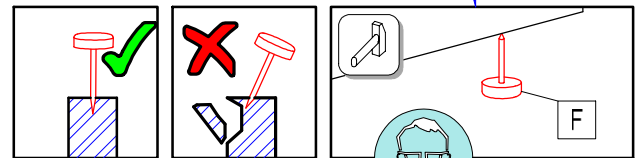
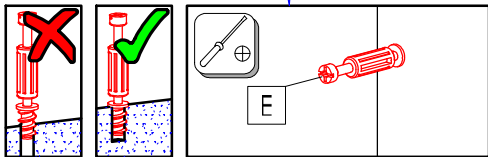
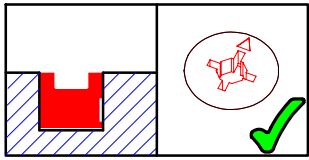
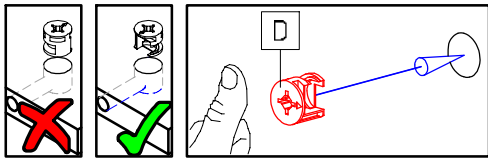
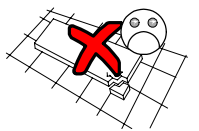
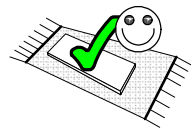

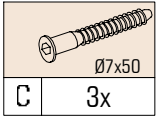



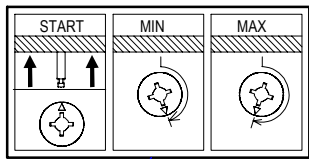
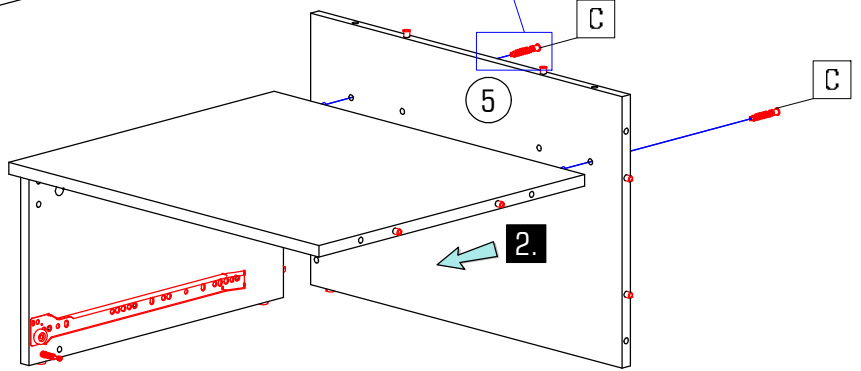
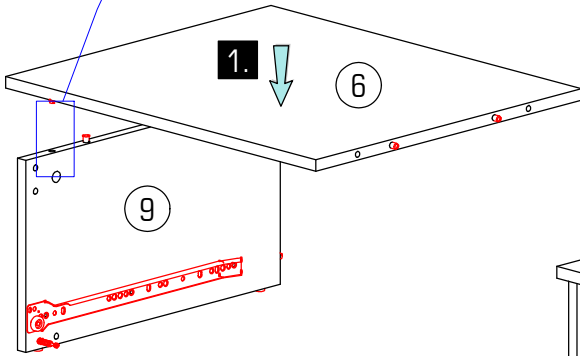
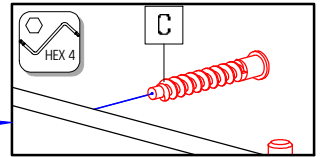
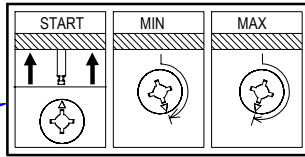

2x

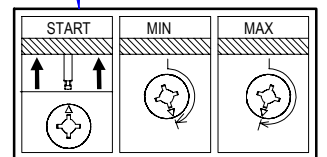
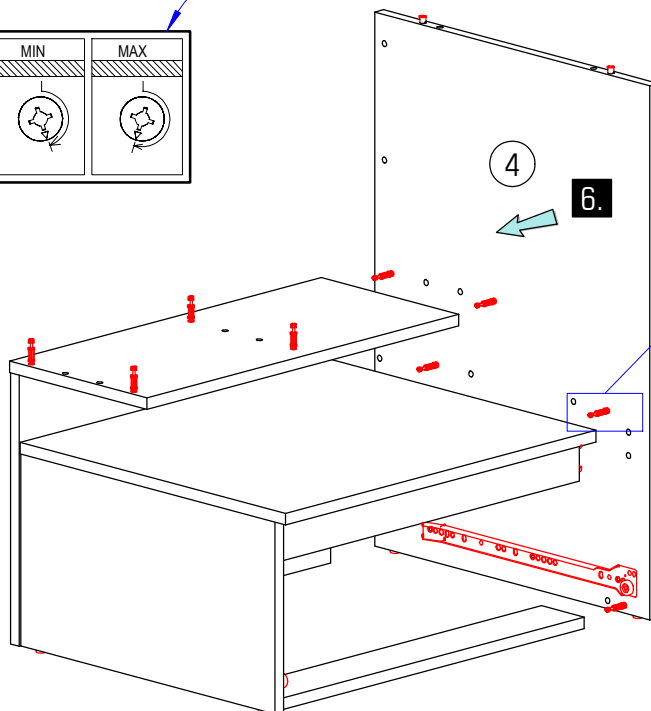
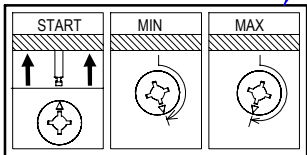
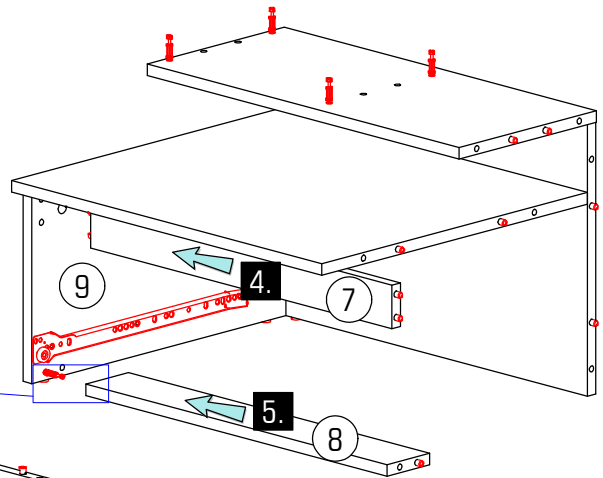
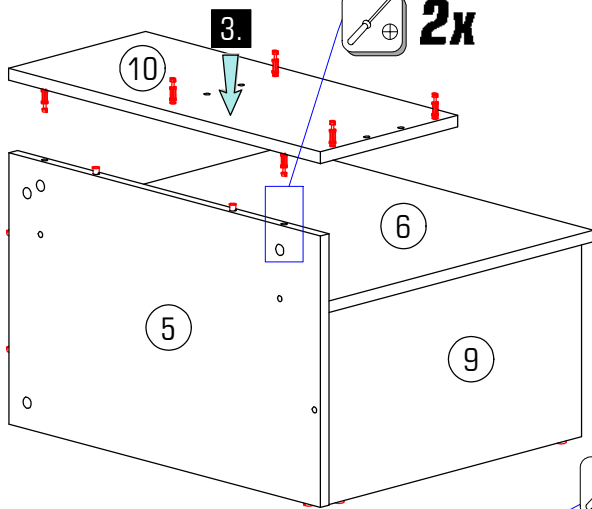

2x

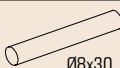

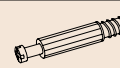

# 4/8 EROSS NEW

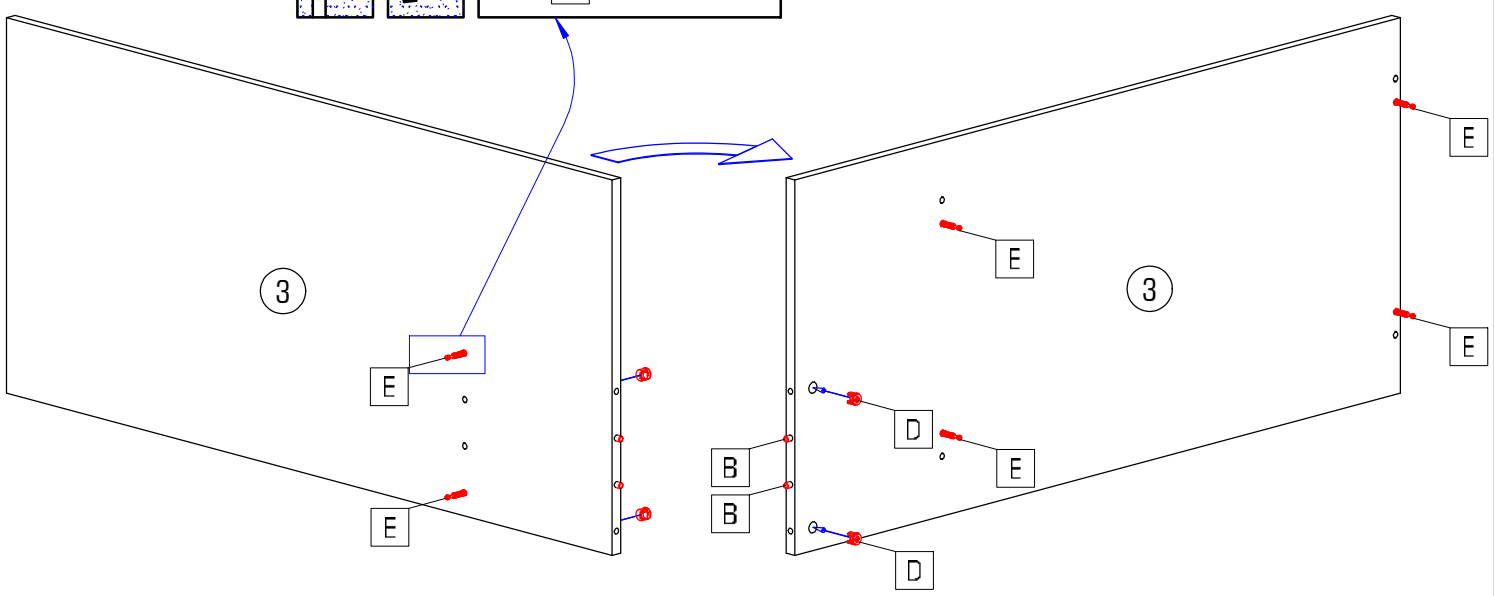
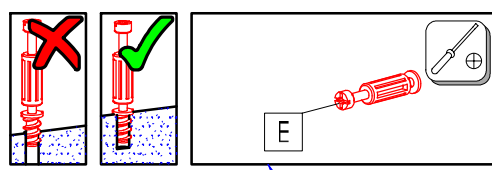
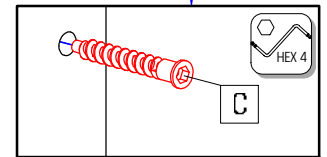
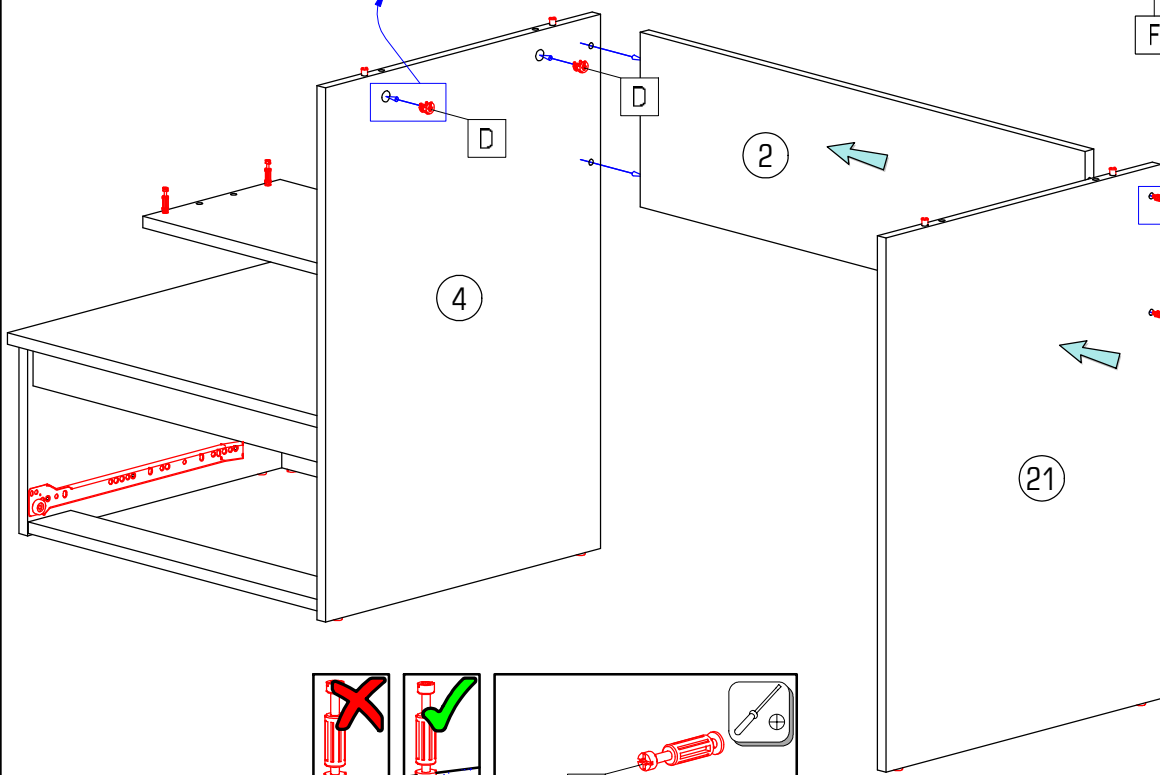
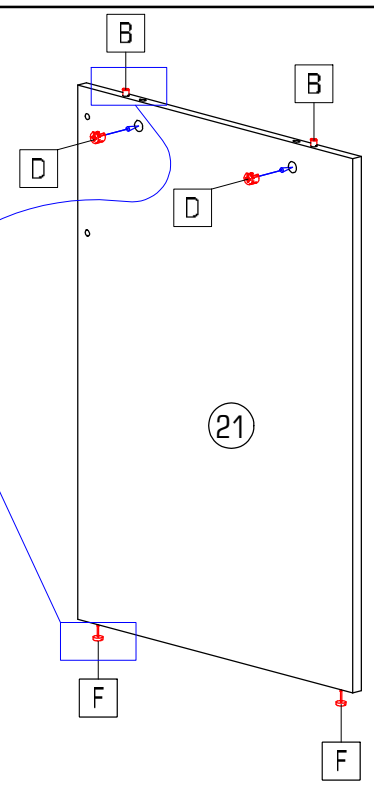
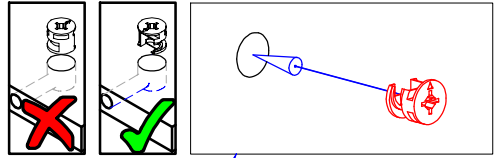
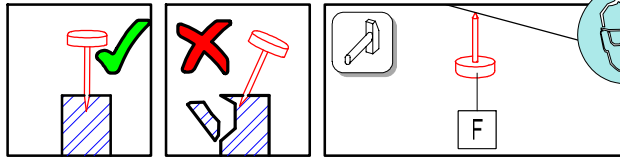
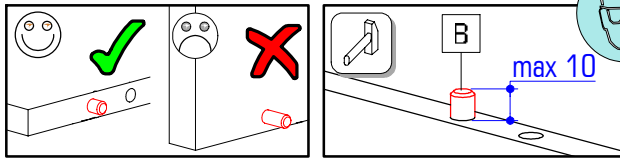
|  |   |   |   |   |   |
|--|---|---|---|---|---|
|  |  |  |  |  |  |
| B 4x   | C 4x  | D 6x  | E 6x  | F 2x  | M 2x  |

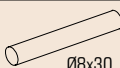

# EROSS NEW 5/8

|  |   |   |
|--|---|---|
|  |  |  |
| Ø8x30  |   | Ø15x13  |
| B 4x   | L 2x  | D 4x  |

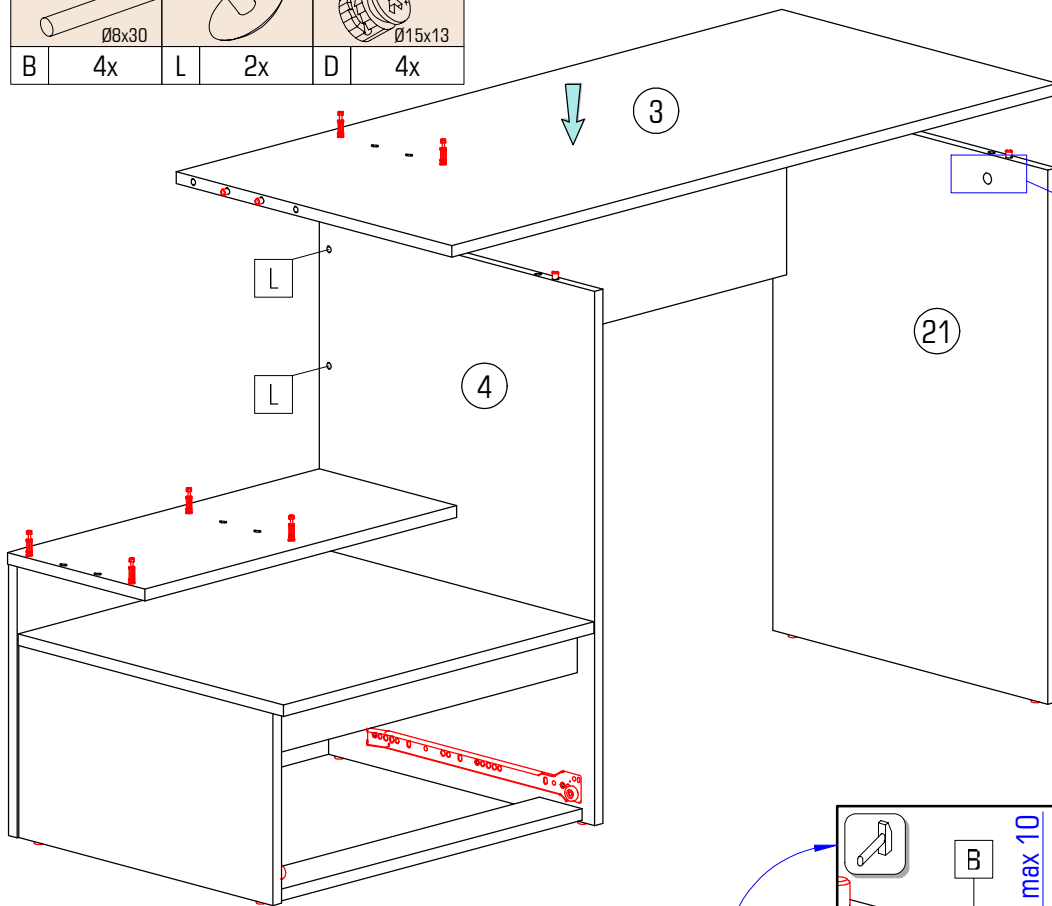
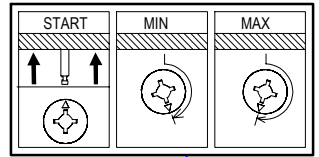

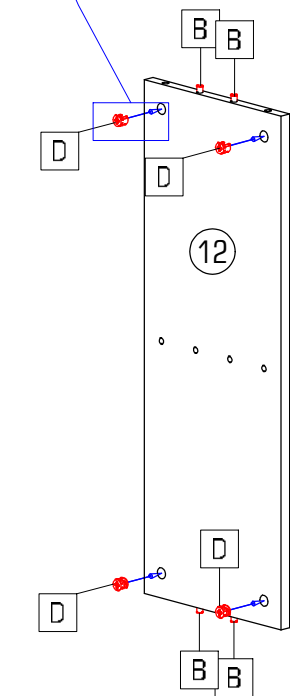
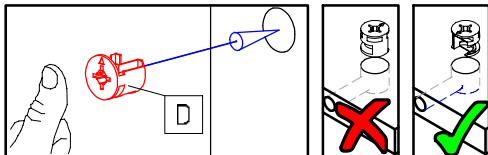
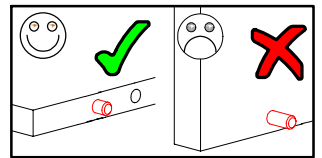
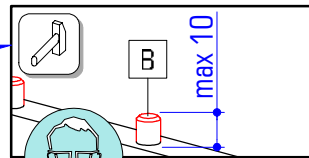

 **4x**

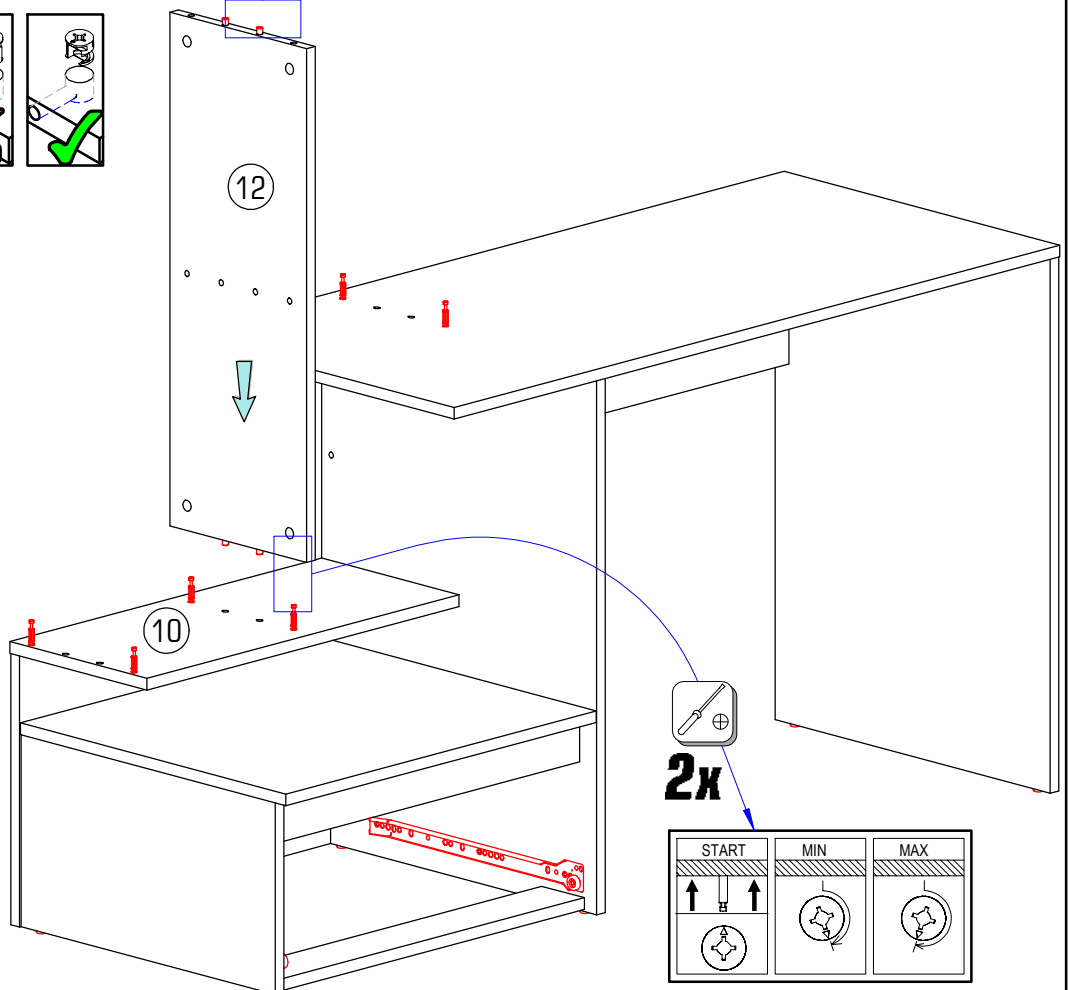
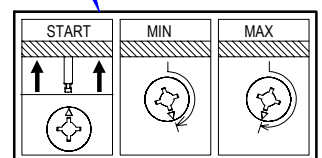

 **2x**



# 6/8 EROSS NEW

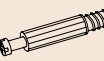
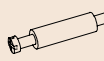

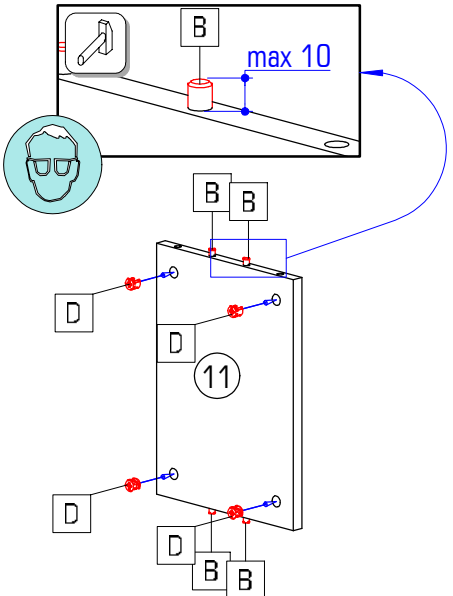
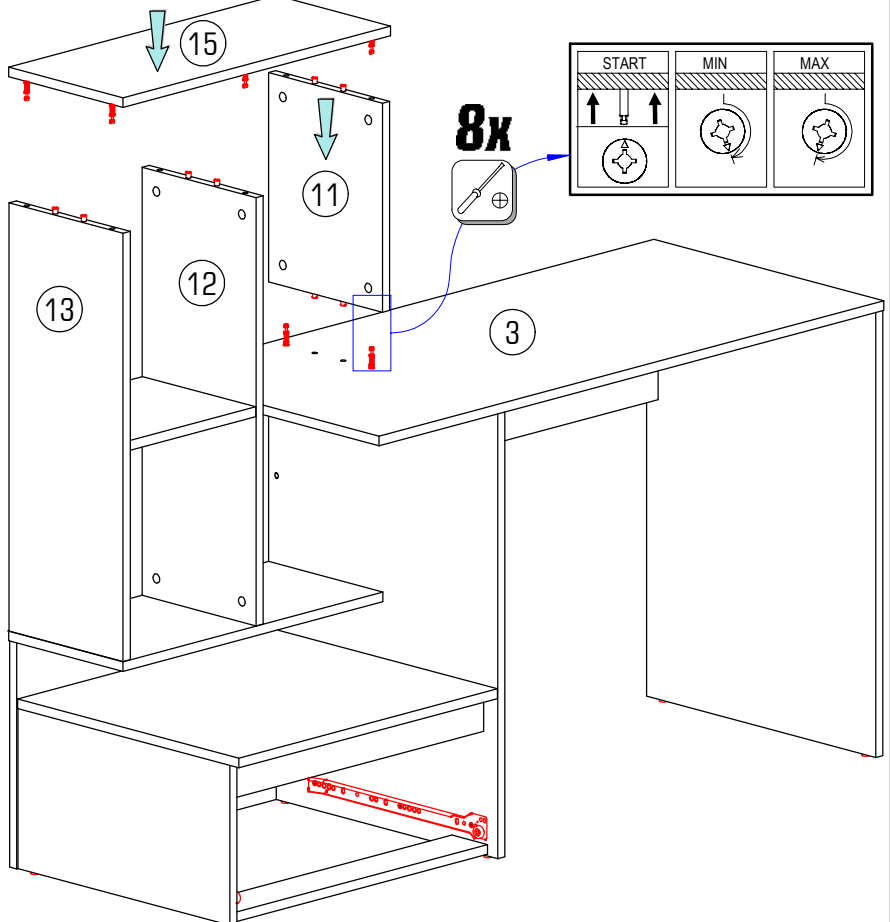
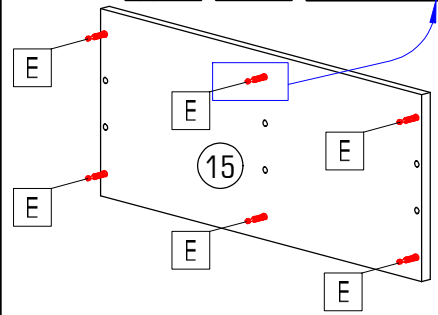
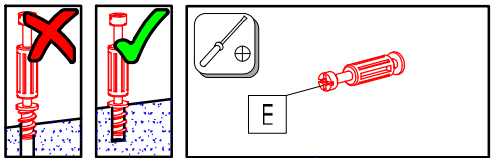
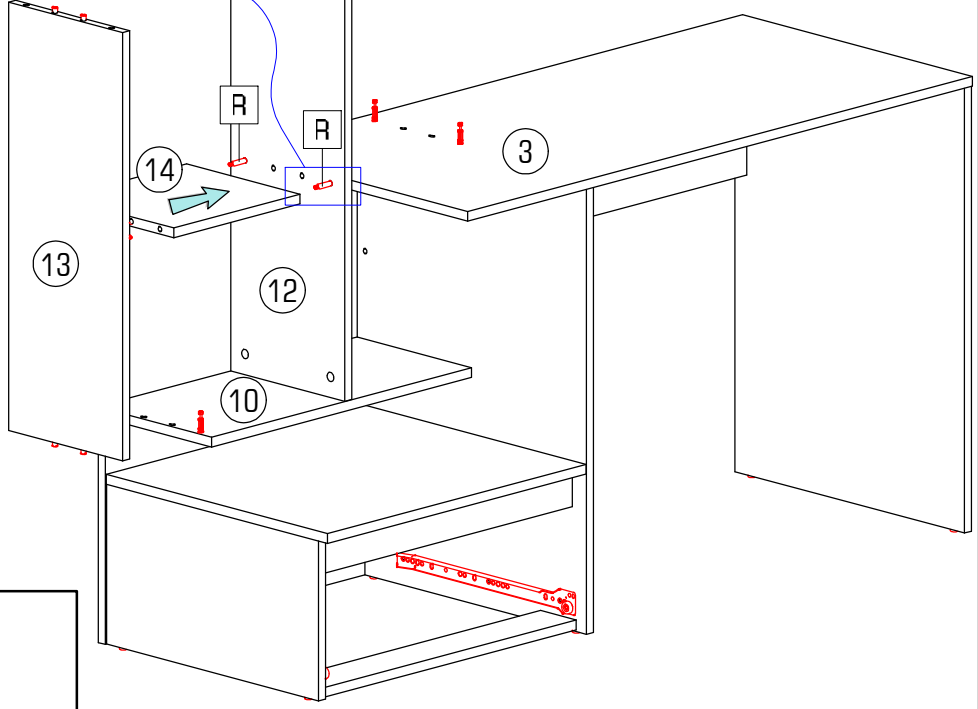
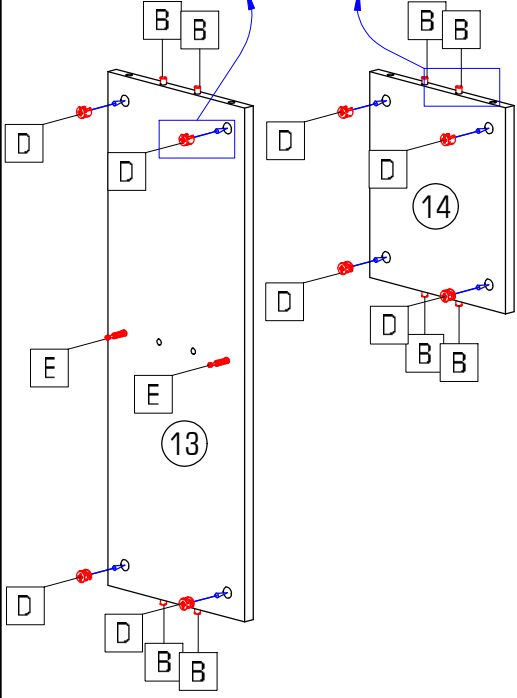
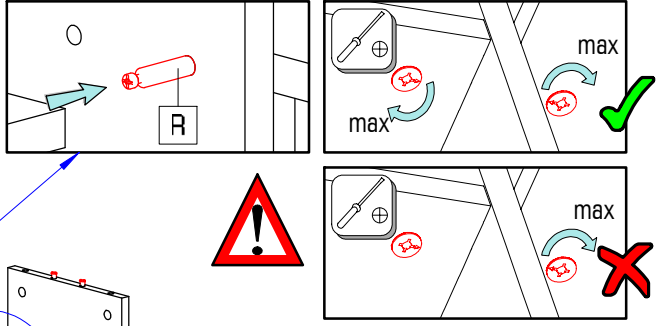
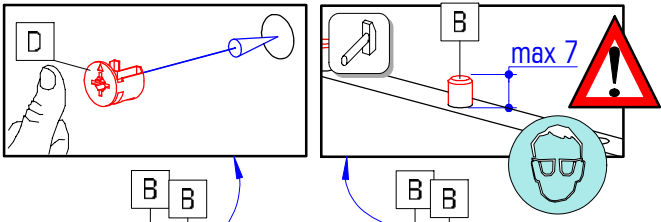
|  |   |   |   |
|--|---|---|---|
|  |  |  |  |
| B 12x  | D 12x   | E 8x  | R 2x  |

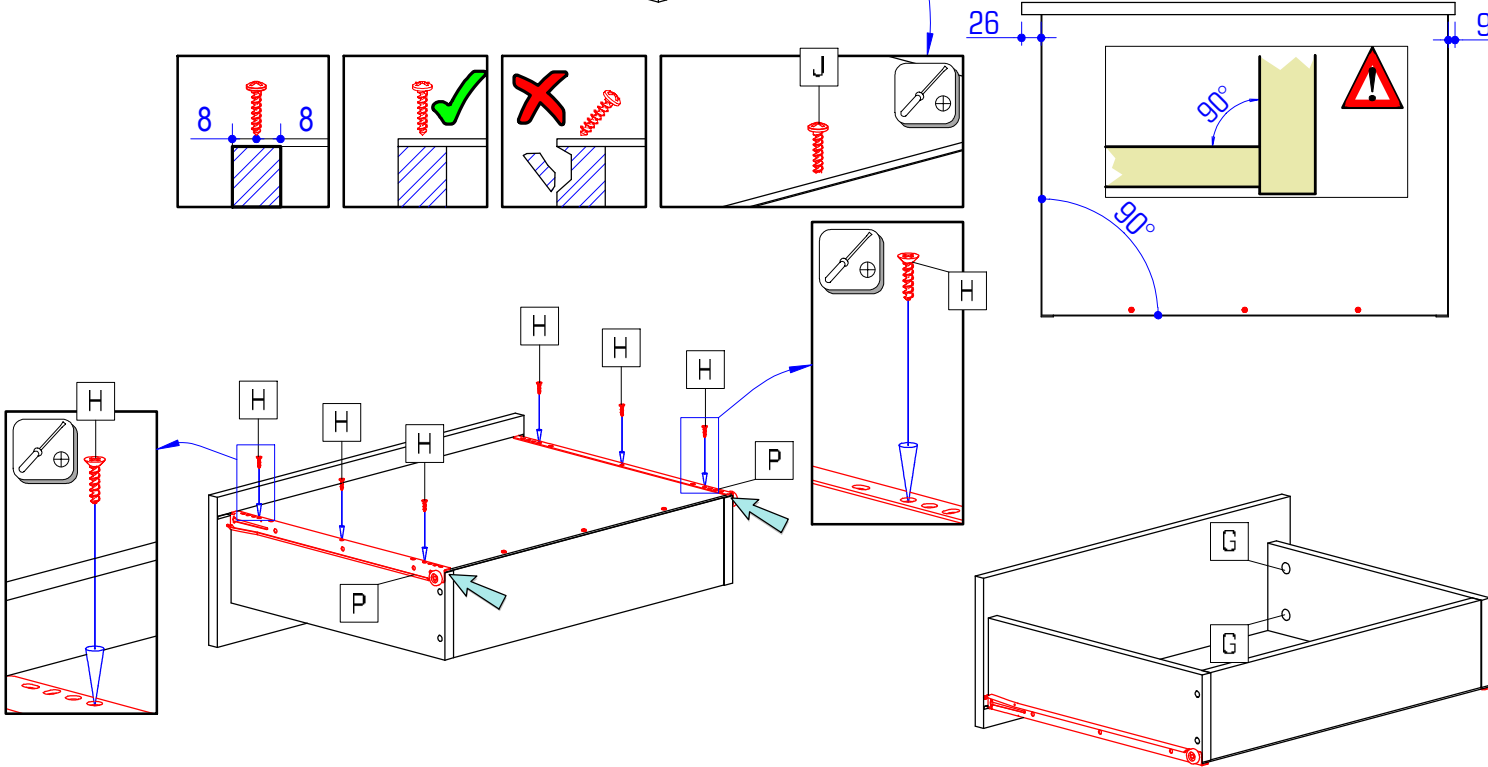
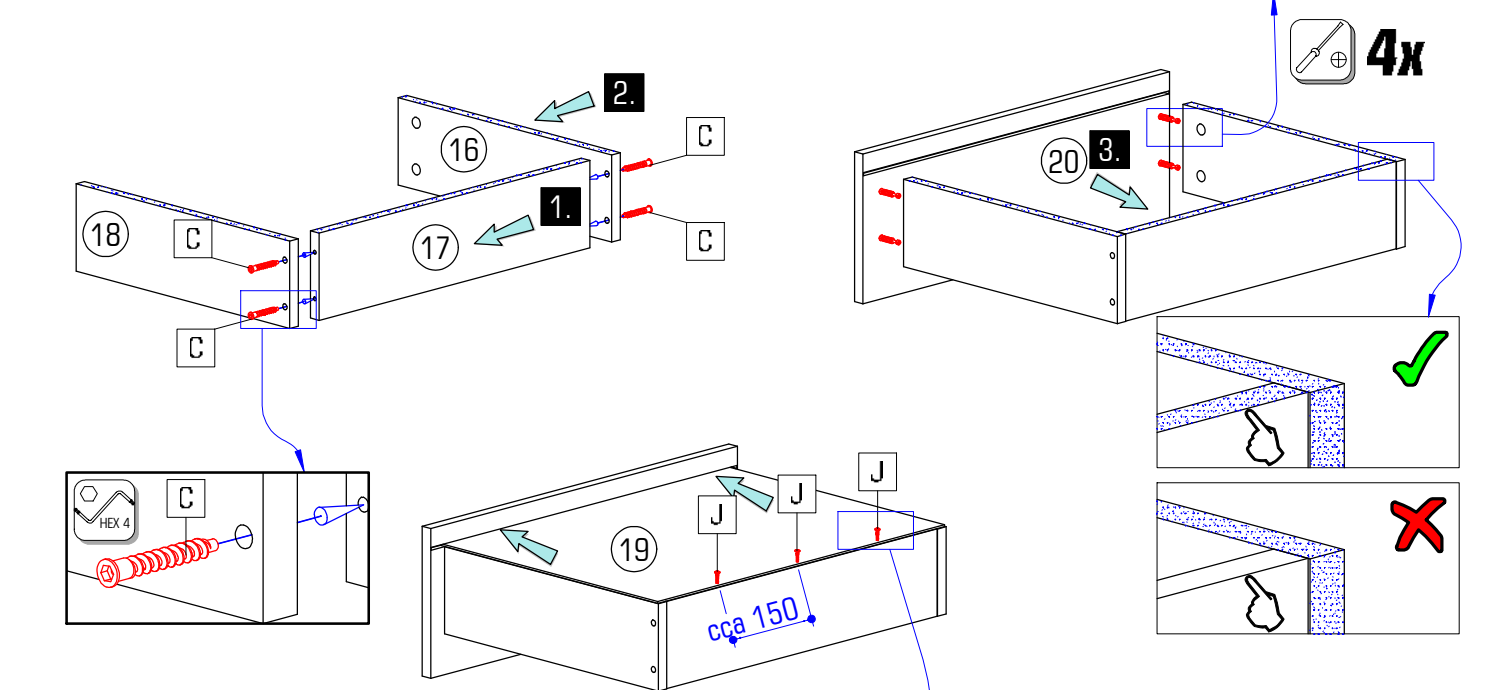
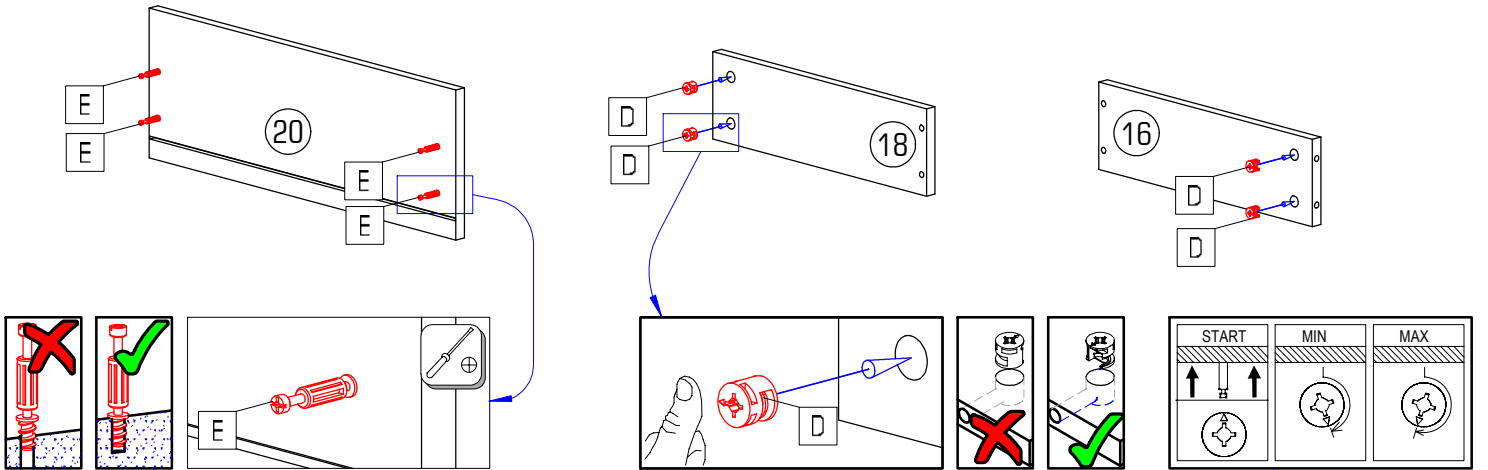

|      |      |      |      |      |      |
|------|------|------|------|------|------|
|      |      |      |      |      |      |
| C 4x | D 4x | E 4x | G 4x | H 6x | J 3x |
|      |      |      |      |      | P 1x |



# 8/8 EROSS NEW

|   |     |   |     |
|---|-----|---|-----|
|  |     |  |     |
| A   | 10x | G   | 12x |

